

# DESIGN OF A PROTOTYPE ROBOT VACUUM CLEANER

## *From Virtual Prototyping to Real Development*

Leire Maruri, Ana Martinez-Esnaola, Joseba Landaluze  
*IKERLAN Research Centre, Arizmendiarrieta 2, E-20500 Arrasate (The Basque Country), Spain*

Sergio Casas, Marcos Fernandez  
*ARTEC Group, Valencia University, E-46980 Paterna, Spain*

**Keywords:** Robot vacuum cleaner, Virtual prototype, Fuzzy logic, SIL (Software-In-the-Loop).

**Abstract:** This paper presents the prototype of a robot vacuum cleaner designed and constructed by IKERLAN. It details, above all, the hardware and software components used, as well as the navigation algorithm, designed using fuzzy logic. In conjunction to this an existing virtual prototype of the robot and the domestic environment was updated with a view to fine-tuning and testing the real controller of the autonomous robot by means of SIL (Software-in-the-Loop) simulations. Finally, some of the position estimation problems that arose in the experimental tests are described.

## 1 INTRODUCTION

Modern living brings with it the need to use time as efficiently as possible, one of the key objectives being to create as much free-time for ourselves as we possibly can. This explains why people increasingly surround themselves with appliances capable of carrying out essential, yet distinctly unappealing, household chores. It is here that domestic appliances have a role to play.

Until not so very long ago, a washing machine and fridge were considered sufficient. However, when these household appliances, along with the tumble dryer, hair dryer, microwave, vacuum cleaner, etc. became commonplace in the home, they were required not only to perform the task for which they were designed, but to do so in the simplest and most efficient way possible. What is more, demand is increasing with every passing day for new household appliances capable of making even the most tedious jobs bearable, such as ironing or cleaning in general. In an ideal world, the domestic appliances of today would even be replaced by new gadgets with ability to perform tasks in a completely independent way, which is where concepts such as domotics and domestic robots come in.

One such device is the robot vacuum cleaner, a very active area of research for several years now,

with many prototypes having been developed, some of which are now appearing on the market (Irobot, 2006; Electrolux, 2006; Karcher, 2006).

The robot vacuum cleaner is a special case among mobile robot systems. Taking as a starting point the principle of a robot capable of navigating reactively in theoretically unknown environments and designed to avoid variable obstacles, a number of different versions of domestic cleaners can be obtained (ones that vacuum the floor, wash dishes, polish furniture, etc.) by fitting the requisite accessories. In order for a robot vacuum cleaner to take its place among the numerous domestic appliances on the market today, however, it must meet some very specific requirements with regard to price, simplicity, ease of use, independence from the surrounding environment and cleaning efficiency among others.

Over the last few years IKERLAN and the ARTEC Group at the University of Valencia have been working on the design of a domestic robot, particularly as an example of the application of HIL (Hardware-in-the-Loop) technology in the design of new industrial products. Research was conducted on the navigation system (sensors, actuators, and navigation and sweeping algorithms) and tested using the virtual prototype of a generic robot vacuum and a domestic environment in HIL simulation (Fernandez, 2003; Martinez, 2004).



Figure 1: Commercial robot vacuum cleaners: Trilobite, RoboCleaner and Roomba.

More recently, a prototype robot vacuum was designed and constructed. The virtual prototype of the mobile robot and the domestic environment was also improved. Among other things, an accurate model of the vacuum cleaner was added, other dynamically changing elements were included (such a ball that appears in the environment) and a version for Windows/PC was created. As a result, the control programme designed was fine-tuned and tested using the virtual prototype, following a SIL (Software-in-the-Loop) procedure.

This paper presents the most significant aspects of the robot vacuum cleaner prototype that has been designed and constructed; its navigation system, based on fuzzy logic; and the improved version of the virtual prototype. First of all, the paper briefly reviews the current situation with regard to research on robot vacuum cleaners, placing special emphasis on the designs that are currently available on the market. It then goes on to describe the hardware and software contained in the robot vacuum cleaner designed, as well as the navigation strategy. After detailing the virtual prototype, the paper concludes by presenting some of the position estimation problems that arose in the experimental tests.

## 2 BRIEF REVIEW OF ROBOT VACUUM CLEANERS

After years of fits and starts, the market for robot housemaids finally seems to be taking off. New models of robot vacuum cleaners are the first signs that a nascent commercial robot industry is finally taking hold. However, the robot vacuums now being sold are not designed to replace the vacuum cleaner altogether. The manufacturers describe their products as "maintenance" or "continuous" cleaners (Kahney, 2003). There are a lot of models of robotic vacuum cleaners available today, and they range in price from \$50 all the way up to \$1,800. These robots are typically low-slung and compact, meaning

they can get under furniture normally inaccessible to regular upright vacuum cleaners.

There are three leading robot vacuum companies: Europe's Electrolux and Karcher, and the United States' iRobot (Figure 1). Other cleaning manufacturers like Japan's Hitachi and the UK's Dyson are working on the development of this kind of robot, as are Friendly Robotics, FloorBotics, Hanoor Robotics, Samsung and Lentek.

The most popular robotic vacuum in the United States is iRobot's *Roomba*, which comes in various models ranging from the base-model *Roomba Red* (\$150) to the super high-tech *Roomba Scheduler* (\$350). It is a round-shaped vacuum-device that works like a pool cleaner, bouncing around a room until it covers all - or most of - the floor (Kahney, 2003). The cleaning system includes a spinning side brush that cleans along walls, two counter-rotating brushes that capture large debris and a vacuum that picks up dust. At the end of a cleaning cycle or when the battery is running low, *Roomba* returns to the Home Base to recharge. When dirt hits one of the two sensors located immediately above the brushes, it turns towards the dirty area, vigorously cleaning the area most in need of attention. It also includes infrared sensors that prevent *Roomba* from falling off ledges and stairs. The system includes virtual walls that create an infrared signal that *Roomba* will not cross, keeping *Roomba* where you want it to clean (iRobot, 2006).

Electrolux's *Trilobite* is more complex, and more expensive. The \$1800 *Trilobite* creates an internal map of the room as it cleans, and recharges automatically when its power reserves are low. The type of cleaning programme you want can be selected (normal, quick or spot) and it has a start button for immediate cleaning, or alternatively cleaning times may be set in advance. The *Trilobite* sends out harmless ultrasonic signals to spot objects and avoid them. It begins by edging along the walls to map the size of the room, whilst simultaneously cleaning the edges. It then proceeds to clean the

whole room. A suspension device prevents the machine from getting stuck, and a special sensor stops it from falling down stairs (Electrolux, 2006).

Kärcher's *RoboCleaner* (Karcher, 2006) is available for about 1100€. It takes a "random-walk" around the house, sensing walls and obstacles with its touch-sensitive bumpers. It avoids stairs, and is low enough to fit under most furniture. A pair of "rubber ears" on top prevents it from getting stuck. The *RoboCleaner* monitors the stream of incoming dirt and concentrates on especially dirty spots. The owner need only empty the recharging station's dust bag when it gets full.

The British company Dyson is trying to develop a robot cleaner (*DC06*) and has gone back to the R&D phase until they can make an affordable, autonomous vacuum cleaner.

Japanese electronics giant Hitachi is working on a similar product that also acts as a home security guard. The robot cleaner can work independently or manually, controlled by computer or cell phone. An in-built camera allows the owner to monitor his house over the Internet while away. It comes with a charging station, to which it returns to recharge its batteries and dump its dust load. The robot creates a map of the house's layout as it moves around. It remembers the layout of furniture and which areas of the house have been cleaned and which have not. It has a retractable 2-inch hose for cleaning in corners. The machine bristles with sensors (light, heat and all-around bumpers) for detecting hazards and preventing it from getting stuck in corners.

### 3 ROBOT VACUUM CLEANER DEVELOPED

#### 3.1 Hardware Structure

Design and development of the robot vacuum cleaner prototype was based on off-the-shelf, low-cost components. The *Rex-12 Round Robot Base with Encoders* from Zagros Robotics (2006) was chosen for the mobile structure and support of all the components. It consists of a desk base 30 cm in diameter, which has two drive wheels and is supported on two casters. The drive wheels are 15 cm in diameter and the two caster wheels 7.5 cm in diameter. The base includes two 12 V drive motors for the drive wheels, and each motor has a 500 pulses per revolution HEDS encoder.

The platform can easily carry over 15 kg of payload at a maximum speed of 24 m per minute.

The sensor system uses 16 units of the *SRF08 Ultrasonic Rangefinder Sensor* from Robot

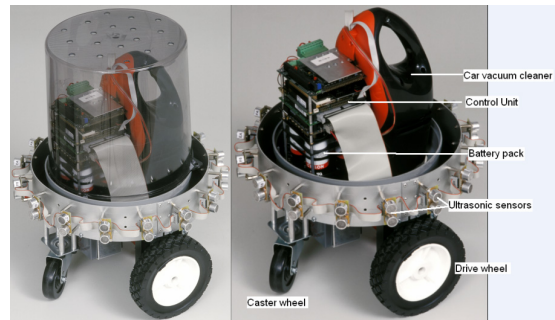

Figure 2: Robot prototype and its components.

Electronics (2006). Communication with the ultrasonic sensors is via an I2C bus. A *BrainStem GPI.0 Module* from Acroname (2006) is used to read the ultrasonic sensors and measure distances to obstacles. The distances measured are sent to the robot controller by means of a RS-232 serial port. In the prototype a car vacuum cleaner has been used to suck up dust.

The control unit consists of a sandwich of PC/104 modules. The modules included are as follows:

- A CPU board, *MOPSIcd7-700 MHz* from Jumptec (2006), with 512 MB of SDRAM and an IDE compatible Flash-Disk of 96 MB.
- *ESC629ER Dual DC Servo Motor Control Board* from RTD (2006) to control the drive motors of the desk base. It has also 24 TTL level I/O lines which are used to control the car vacuum cleaner. A customised circuit was developed for that purpose.
- PCM-3110 1-Slot PCMCIA Module from Advantech (2006).
- *Instant Wireless Network PC Card* from Linksys (2006) for wireless communications.
- *HESC104 Module* from Tri-M Engineering (2006), a DC-to-DC 60 watt converter for embedded applications that supplies  $\pm 5$  V and  $\pm 12$  V.
- *BAT104-SLA45 Battery Pack* from Tri-M Engineering (2006). This is sealed, lead acid battery backup unit for HESC104 power supply. It consists of 5DD x 4.5A Hr batteries with digital temperature sensors.

The battery pack and the HESC104 unit supply the power needed by the drive motors, the car vacuum cleaner and the control unit itself.

By means of the wireless communication link, the robot vacuum cleaner programme is loaded and monitoring data acquired.

Figure 2 shows a photograph of the robot vacuum cleaner prototype developed, as well as its main components.

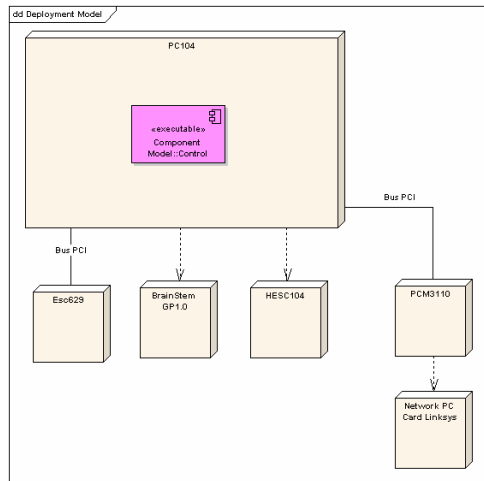

Figure 3: Development diagram of the application.

### 3.2 Software Structure

The Operating System used in the CPU board of the mobile robot is *eLinOS v2.1*, an embedded version of Linux, with *RTAI* extension for hard real-time. The control program is created in a host computer and then downloaded through the wireless link.

The robot controller has been developed in Simulink, where it is tested using a simple virtual environment consisting of a circular or rectangular room. After ensuring it is operating correctly, the code of the navigation algorithm only is created using the *RTW* (Real Time Workshop) utility. This code is then integrated into the application along with the rest of the functionality (reading sensors and the sending of commands to the motors) and compiled for *eLinOS* and *Windows*. This controller is embedded in the mobile robot or can be integrated into the virtual prototype in order to test it.

The controller carries out three basic functions: it receives information from the sensors on the distances measured; it periodically calls the navigation and control algorithm (created with *RTW*) to obtain the wheel velocity commands; and it sends these commands to the motors.

Figure 3 shows the development diagram of the embedded application, representing the application as the “Control” component built into the CPU PC/104, and showing the interaction with the peripherals fitted on the robot vacuum cleaner.

The application functions as per the sequence diagram in Figure 4. As soon as it starts up, the application configures an interruption timer before starting the input and output (sensors and motors) and configuring the operating system signals. At the end of the initialisation process, it enters a loop that

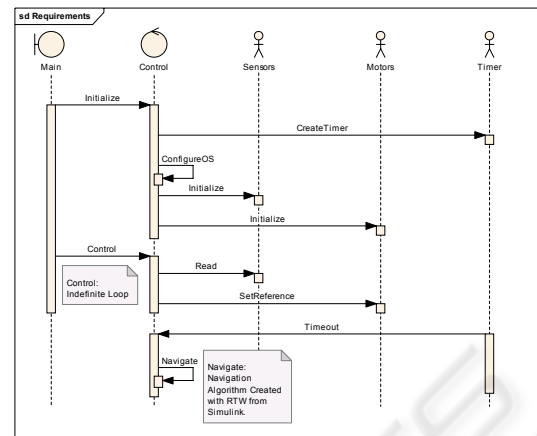

Figure 4: Sequence diagram of the application embedded.

performs two of the basic functions: it reads information from the sensors and sends the velocity commands to the motors. In conjunction, the operating system periodically sends (every 10 ms) signals via the *rigalrm* (alarm signal) function. These signals are captured by the programme and trigger the call to the “navigate” function, which implements the navigation control.

## 4 NAVIGATION SYSTEM

The navigation system, implemented in Matlab/Simulink, provides a navigation algorithm capable of locating a wall in an unknown environment and following it, as well as determining when the boundaries of the enclosed area it is moving in have been defined. It then begins a sweeping phase in which it covers most of the enclosed area in an efficient manner. The navigation system consists, therefore, of three basic stages: identifying the enclosed area to be swept; the sweeping of internal areas; and the bordering of obstacles. Figure 5 shows the statechart diagram of the navigation application.

In the initial stage the robot performs a square spiral during which it moves by alternating between straight lines and right-angle turns until it finds a wall. At this point it moves to the next stage known as “wall following”, which, as its name suggests, involves the robot skirting along walls. Throughout this phase the robot is controlled by the fuzzy control system, which attempts to guide it at a fixed distance from the wall, delimiting the enclosed area in question (Urzelai, 1997).

Once it has been established that the “wall following” phase has marked off an enclosed area (as a result of readings received from the motor

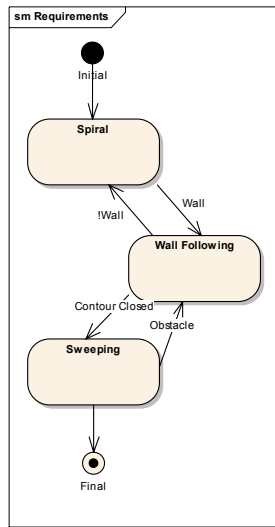

Figure 5: Statechart diagram of the “navigate” function.

encoders), the third and final phase in the application, known as “sweeping”, is performed. Here, the algorithm encloses the trajectory taken by the robot in a cell matrix that enables it to identify the swept area and, on the basis of this, a decision strategy informs it of which cells need to be swept at each point. If at any time an obstacle is detected, the robot switches back to wall-following status and adopts a fuzzy control strategy (the same as the one used in that particular stage).

### 4.1 Fuzzy Wall-following Control

The “wall following” function features three distinct modules or parts: pre-processing, fuzzy control and post-processing.

Pre-processing introduces the concept of the perception vector (Figure 6). This vector indicates the proximity of an obstacle and its direction. The angle of the perception vector is that formed by the direction the robot advances in. The module of the vector expresses the distance the robot is from the wall in a standardised way using an ideal distance value: 1 if the robot is at the wall, and 0 if it is double the ideal distance or further. As a result, the fuzzy control system attempts to keep the module of the perception vector at 0.5, equivalent to the ideal distance. The output in this pre-processing block consists of the module of the perception, the angle of the perception, the derivative of the perception and the loss of perception. This last output indicates whether the robot has switched from measuring perception to a value of 0 (i.e. when the robot moves further than it should from the wall).

The navigation module calculates the velocity commands for the motors. To be able to do this it

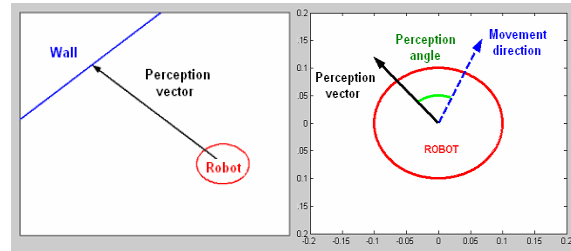

Figure 6: Perception vector and perception angle.

features two strategies represented by the first two stages in the statechart diagram (Figure 5): the first being a wall-search strategy, and the other a wall-following strategy designed to identify the sweeping area. These two control modes are selected according to the value of the perception vector module. If the module has a value equal to one, the control system will search for a wall and will attempt to follow a square spiral pattern until one is found, at which point the loss-of-perception signal resets to zero and the robot attempts to follow the wall thanks to the wall-following control function performed by the fuzzy block.

In the search for walls, the square spiral is generated as a result of two types of commands sent to the wheels: one in which the robot advances in a straight line, with the same command being sent to the two wheels; and the other where the robot rotates 90°, with one wheel receiving a certain velocity command and the other the same command but with a different sign, thereby ensuring that the robot rotates on its axis without lateral displacement.

When the perception value is anything other than zero (meaning that it has found a wall), the fuzzy block performs the control. This block has the “module of the perception” and the absolute value of the “angle of the perception” as inputs, thereby simplifying the fuzzy model, as it is the symmetry of the problem that is used. The system uses three fuzzy variables: *modP* (module of the perception); *angP* (angle of the perception); and *Giro* (the output variable for the robot’s angle of rotation).

The membership functions of the *modP* (module of the perception) input variable appear in Figure 7a. As stated above, this variable provides an estimate of the distance to the wall. The membership functions of the *angP* (angle of the perception) variable appear in Figure 7b. As has already been mentioned, this input is always positive, as it takes the absolute value, making use of the system’s symmetry. In the event of this angle being negative, the sign is changed.

The only output in the block is *Giro*: the rotation that the robot must perform to prevent it from running into, or approaching too close to, the wall, depending on the value of the module of the

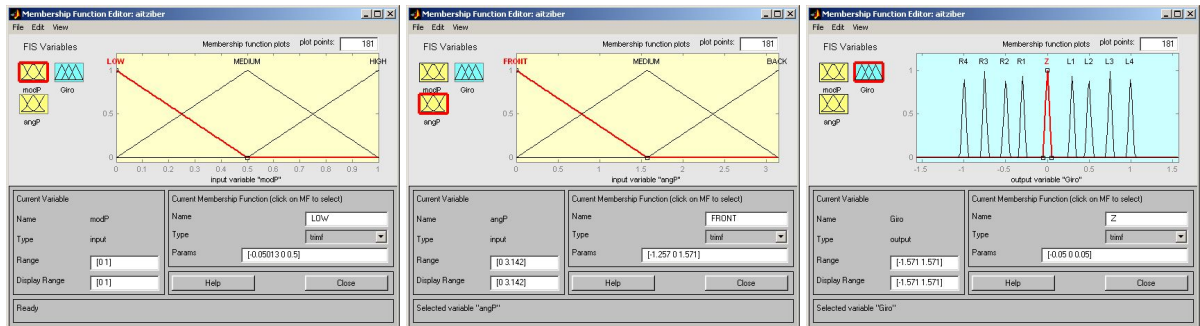

Figure 7: Membership functions of fuzzy variables: a) Perception distance; b) Perception angle; c) Turning angle.

perception. By incorporating the following rules into the fuzzy controller (Figure 7c), the robot vacuum cleaner tries to maintain an angle of 90° between the direction of advance and the wall, being the distance to the wall the ideal one.

<i>modP/angP</i>	Front	Medium	Back
Low	L1	R2	R4
Medium	L3	Z	R3
High	L4	L2	R1

Having established the rotation the robot must perform, the post-processing module calculates the velocity commands to be sent to each of the wheels.

### 4.2 Sweeping Strategy

Existing robot vacuum cleaners on the market that have to move around unknown environments mainly use two navigation strategies. The first involves random navigation, i.e. the robot moves in a straight line until it encounters an obstacle and then changes direction randomly, continuing in a straight line again until coming across the next obstacle. This approach, although not particularly efficient, is very easy to be implemented. The second approach involves mapping the environment as the robot moves so that a reference to the robot position can be obtained and the optimal sweeping strategy defined. The latter approach was that chosen for the design of the sweeping algorithm.

Once the contour has been determined, it is demarcated by a rectangle with as small a surface area as possible. This area is divided into cells with a predetermined size. Each cell has a status: the cell can belong to the contour; the outside of the contour; or the inside of the contour (Figure 8). As a result, the input is restricted to the inside of the contour.

From this point on, the behaviour of the prototype is no longer controlled by fuzzy rules. The robot proceeds to use the matrix obtained in the first stage to calculate the points of its next path.

Therefore, some of the cells will change their status from “inside” to “path”. The cells with the “path” status are converted into “swept” cells. If the room were completely empty, the robot would sweep the room in a spiral.

The process of sweeping inner areas is repeated continuously until 3% of the area initially selected for the task is left. At this point, the prototype detects the zones that are still unswept, known as “islands”. The robot chooses only those “islands” that are larger than the size of the robot vacuum cleaner. Then the robot selects the “island” nearest to its position and approaches it by the shortest route. Each island then becomes a “small room” to be cleaned, and sweeping is controlled by the same rules of behaviour. Once all the islands have been swept, the robot considers the task completed.

## 5 VIRTUAL PROTOTYPE OF ROBOT VACUUM CLEANER

As stated above, one of the main objectives of the research carried out by IKERLAN and ARTEC was to validate the use of HIL methodology in designing and implementing the real prototype. Thus, in order to provide a realistic environment in which to test the robot vacuum cleaner, a real-time realistic 3D simulation was developed alongside the real prototype. This allowed us to test the HIL strategies

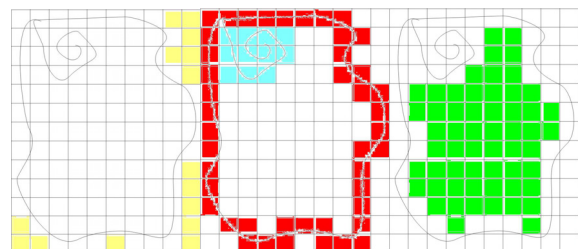

Figure 8: a) Cells outside of the contour; b) Cells on the spiral and the contour; c) Cells to be swept.



Figure 9: Virtual Prototype: a) General view with a random object; b) Swept area.

by having a better feedback and a visual first impression of how the control system behaved.

## 5.1 Description

This virtual prototype is a standalone, real-time, graphic/dynamic simulation written in C++ that runs on both *Windows* and *Linux* operating systems.

The virtual prototype simulation (hereinafter referred to as “simulation”) is a multi-threaded real-time oriented application composed of three main subsystems (Fernandez, 2003):

- 3D real-time graphic subsystem: an OpenGL Performer-based module responsible for providing realism and visual quality to the application. It takes advantage of the scene-graph representation of the visual information while using advanced graphic techniques to enhance the user’s sense of “immersion”.
- Dynamic simulation subsystem: given the task of providing the application with realistic Newtonian physics; based on the Open Dynamics Engine (ODE).
- Communication subsystem: the module where the simulation communicates with the control system in order to get actuator feedback and provide sensor information.

## 5.2 Improvements in Relation to the Existing Prototype

Several changes have been made to the architecture of the existing prototype (Fernandez, 2003; Martinez, 2004); the most apparent of which is the migration to a Windows-based application.

A subtle, yet important, difference with respect to the existing prototype is that this revised version of the simulation is able to run independently from (provided it is supplied with values for the motor velocities), or alongside, the control system

developed by IKERLAN. This link can be made with either the hardware prototype or the software controller that substitutes it, and, as such, HIL (Hardware-in-the-Loop) becomes SIL (Software-in-the-Loop).

Little has changed with respect to the existing version of the graphic subsystem, although new, more complex 3D models of both the robot vacuum cleaner and the environment (with a new set of furniture and home-related items to test the robot over more challenging conditions than it was done using the previous prototype) were built.

The dynamic subsystem, nonetheless, has undergone some dramatic changes in order to adapt it to the new robot configuration designed by IKERLAN. This includes some new joints, the redesign of the locomotion system and a new (and very necessary) stabilization system. Without this, the simulation would have not been able to meet the new time requirements imposed by the increased complexity of the new graphic models. Likewise, random objects (such as a football, Figure 9a) have also been introduced into the simulation, in order to test the ability of the robot to react to unexpected events and objects which suddenly appear in its path.

Finally, the communication subsystem was also changed in order to provide a software interface with the Simulink-based software version of the controller. This allows us to test the navigation software directly against the virtual prototype, instead of having to load it into a hardware platform. The solution could thus be termed a loophole within the Software in the Loop.

## 6 EVALUATION OF RESULTS

The existing virtual prototype described in (Fernandez, 2003) and (Martinez, 2004) is simpler and was used to evaluate different sensing

alternatives and navigation strategies. The conclusions reached (Martinez, 2004) provided the starting point for the design and construction of the real prototype described and presented in this paper. Once the robot had been designed (Figure 2), the virtual prototype of the robot and the domestic environment was updated and enhanced (Figure 9), as described in section 5. The new virtual prototype was used to test, above all, the controller in the real prototype and particularly the navigation and sweeping strategies. The activation of a trace mechanism showing the robot's path, as shown in Figure 9b, was extremely useful for checking the effectiveness of the sweeping algorithm.

By the end of the process, the real prototype of the robot vacuum cleaner had been tested experimentally in simple wall-following and living-space sweeping tasks. The results for wall following were positive (Figure 10), although variations were detected in the estimation of the distance to the wall whenever the wall material changed (e.g. when the robot passed in front of a wooden door). By contrast, the results for the sweeping tasks were worse due to errors in estimating position using measurements from the wheel encoders. These errors led to the fact that the algorithm used for the sweeping of enclosed areas was inefficient. The main reason for this was that due to the wheels slipping the measurements provided by the wheel encoders were inaccurate. This problem had already been detected in the SIL simulation with the virtual prototype whenever there was a change in the surface friction coefficient (e.g. when the robot moved from a rug onto parquet flooring, Figure 9b), but was much more serious in the real prototype.

To draw conclusions from the experimental tests conducted: the sensing system must be modified or completed before moving on to a commercial prototype so that an accurate estimate of the real position of the robot (the basis of the designed sweeping algorithm) can be obtained.

## 7 CONCLUSIONS

This paper presented the prototype of a robot vacuum cleaner designed and constructed by IKERLAN. It detailed, above all, the hardware and software components used, in addition to the navigation algorithm, the design of which was based on fuzzy logic. Moreover, an existing virtual prototype of the robot and its domestic environment were updated, thereby enabling the fine-tuning and testing of the real in-built control of the autonomous robot using SIL (Software-in-the-Loop) simulations.



Figure 10: Real Prototype in the wall-following task.

Finally, the problems arising from the experimental tests conducted were described in detail, and the conclusion reached that the sensing system must be improved so that the real position of the robot, which forms the basis of the sweeping algorithm designed, can be estimated accurately.

## ACKNOWLEDGEMENTS

The material used in this paper was partly funded by the Spanish Ministry of Science and Technology and FEDER (research project DPI2002-04438-C02-01).

## REFERENCES

- Acroname. 2006. [www.acroname.com](http://www.acroname.com)
- Advantech. 2006. [www.advantech.com](http://www.advantech.com)
- Electrolux. 2006. <http://trilobite.electrolux.co.uk/>
- Fernandez, M., S. Casas, A. Martinez, L. Nuñez, D. Guzman, D. Villaverde and J. Landaluze. 2003. Virtual Prototyping of a Domestic Robot for Design and Navigation Optimisation. *In Industrial Simulation Conference ISC'2003*. 9-11 June, Valencia, Spain.
- Irobot. 2006. <http://www.irobot.com/home.cfm>
- Jumpteck. 2006. [www.jumpteck.com](http://www.jumpteck.com)
- Kahney, L. 2003. Robot Vacs Are in the House. *Wired News*. Retrieved January, 2006, from <http://www.wired.com/news/technology/0,1282,59237,00.html>
- Karcher. 2006. <http://www.robocleaner.de>
- LinkSys. 2006. [www.linksys.com](http://www.linksys.com)
- Martinez, A., L. Nuñez, M. Fernandez, S. Casas and J. Landaluze. 2004. Virtual Prototyping of a Domestic Mobile Robot for Design and Navigation Optimisation. *In the International Journal of Engineering Simulation*, ISSN 1468-1137, vol. 5, number 2, pp. 12-20. July.
- Robot Electronics. 2006. [www.robot-electronics.co.uk](http://www.robot-electronics.co.uk)
- RTD. 2006. [www.rtd.com](http://www.rtd.com)
- Tri-M. 2006. [www.tri-m.com](http://www.tri-m.com)
- Urzelai, J., J.P. Uribe and J.M. Ezkerra. 1997. Fuzzy Controller for Wall Following with a Non-Holonomous Mobile Robot. *Fuzzy IEEE*.
- Zagros Robotics. 2006. [www.zagrosrobotics.com](http://www.zagrosrobotics.com)