

ADVANCE DUPLICATE ADDRESS DETECTION (DAD) AND BUFFERING-BASED PROVISION OF SEAMLESS HANDOVER IN MOBILE IPV6

Shobhan Adhikari, Teerapat Sanguankotchakorn

Telecommunications Field of Study, School of Advanced Technologies, Asian Institute of Technology, P.O. Box 4, Klong Luang, Pathumthani 12120, Thailand

Keywords: Seamless Handover, Mobile IPv6, Buffering, Simulation, NS-2, Smooth Handover, Fast Handover, Performance Analysis.

Abstract: Due to the concerns about the imminent crunch in available addresses in the previous version of Internet Protocol, IPv4, and to offer additional functionalities for new devices, IPv6 was proposed. Mobile IPv6 (MIPv6), an extension to IPv6, manages Mobile Nodes' movements between wireless IPv6 networks. One of the most important considerations for Mobile IPv6 is handover management. It is desired that handover be fast and lossless. Seamless handovers are such that they incur minimum packet loss and delay. Various proposals have been made for seamless handover in MIPv6. By forwarding the packets destined to the Mobile Node towards the new point of attachment and storing the packets there until the Mobile Node has attached there, packet loss can be significantly decreased, and the delay associated with the forwarding is also less compared to forwarding from the previous point. In this paper, we study the performance of one such scheme which has optimized fast handover over hierarchical structure with buffering and simulation using NS-2 to evaluate packet loss and delay for UDP streams. It was observed that with the buffering scheme used, the handover was seamless. There was a difference in latencies with and without handover, as expected. It was observed that most of the performance factors studied depended on the data rate of the traffic. The factors were found to be more dependent on the data rate than on the speed of the Mobile Node.

1 INTRODUCTION

With the increasing use of Internet capable and handheld wireless devices, the requirement of seamless handover has driven various proposals towards decreasing the delay and loss associated with handover.

In Mobile IPv6, each time Mobile Node (MN) moves from one subnet to another, it gets a new Care-of Address (CoA). After obtaining a CoA, it registers Binding, consisting of its new Care-of Address, the home address and the registration lifetime, with the Home Agent (HA) and the Correspondent Node(s) (CN(s)) it is communicating with. In case of CN without MN binding, packets reach HA and from there are tunneled to CoA, whereas CN with knowledge of the Binding can send the packets directly to MN's CoA. As the number of MNs increases and cell sizes start to shrink to increase the capacity, number of Binding Updates increases proportionately, causing a

significant signaling overhead. For solving this problem, Hierarchical Mobile IPv6 (HMIPv6) was proposed (Castelluccia, 1998). In HMIPv6, Mobility Anchor Point (MAP), router highest in the hierarchy in the visited network, acts like a local HA for the visiting MN. It also limits the amount of signaling required outside MAP's domain. The hierarchical scheme separates local mobility (micro-mobility) from regional mobility (macro-mobility). MN changes only the Local Care-of Address (LCoA) inside a local domain and not the Regional Care-of Address (RCoA). Packets addressed to MN's RCoA are routed to the subnet, intercepted by MAP, and tunneled to MN's LCoA. This scheme improves handover performance and reduces signaling load.

With fast handover (Koodli, 2003), the delay involved with handover is reduced, the latency being comparable to L2 handover latency. It reduces packet loss by providing fast IP connectivity as soon as MN changes to a new point of attachment. Fast Handover may either be Tunnel-based or Anticipated Handovers. In case of Tunnel-based

Handover, routing is fixed during link configuration and binding update, so that packets delivered to the Old CoA (OCoA) are forwarded to the New CoA (NCoA) by setting up a bidirectional tunnel between old access point and new access point. In Anticipated Handover, FMIPv6 provides support for pre-configuration of link information (such as the subnet prefix) in the new subnet while MN is still attached to the old subnet, by the use of L2 triggers. This reduces the amount of pre-configuration time in the new subnet. Fast Handover scheme is analyzed in (Pack and Choi, 2003). For better results, Hierarchical structure and Fast Handover can be used together (Jung et al., 2004). According to (Perez-Costa et al., 2003), performance of combination of HMIPv6 and FMIPv6 is better than either of them acting alone.

But even with fast handover, there still is a probability of packet loss. Bi-casting is a viable scheme wherein MAP performs bi-casting to both Previous Access Router (PAR) and New Access Router (NAR), so that they both initiate sending of packets to MN's OCoA and NCoA in response to handover indication. But bi-casting is not very efficient because of the overhead involved with sending packets to both addresses, causing redundancy. To decrease redundancy, coordinated bi-casting could be performed. In such a scheme, NAR and PAR agree on a switching point, which defines the exact moment for switching service from PAR to NAR.

The various factors contributing to handover delays are: IP address assignment when DHCP server is far from MN (in case of Stateful (Bound et al., 2001) Auto-Configuration), Duplicate Address Detection (DAD) and Neighbor Discovery (ND) are the main contributors to the latency. The other contributors are the various signaling. Handover latency can be decreased if the delays due to the factors mentioned can be decreased. After forming a new CoA, with either Stateless (Thomas and Narten, 1998) or Stateful Auto-configuration, MN may perform DAD on it. For DAD, MN sends one or more Neighbor Solicitations to its new address and waits for a response for at least one second, hence contributing a significant portion to the total handover delay (Montavont and Noel, 2003). Hence, with some scheme to reduce this delay, the overall handover delay could be reduced significantly. (Lee et al., 2001) has a scheme where MN performs DAD while using OCoA and packets are buffered at PAR during handover. With this, packets have to travel the distance PAR-MAP-NAR while they are forwarded to MN. To improve performance further, buffering could be done at NAR so that buffered packets can avoid the additional distance of PAR-MAP.

Advance DAD (Han et al., 2003) can be used to reduce the delay contributed by DAD to the overall handover delay. Advance DAD scheme automatically allocates a globally routable IPv6 CoA for the use of MNs that participate in fast handover.

Buffering reduces packet loss by storing packets destined for MN during the time MN is handing over and forwarding the same to MN after it has established link connectivity.

2 RELATED WORKS

In this section, some related works for fast and lossless handover are described. Related works for mainly fast and lossless handovers for Mobile IPv6 are discussed.

(Perez-Costa et al., 2003) study the performance of Mobile IPv6, Hierarchical Mobile IPv6, Fast Handover for Mobile IPv6 and their combination. From their study, they show that the performance of combination of HMIPv6 and FMIPv6 (H+F MIPv6) is better than either HMIPv6 or FMIPv6. It has been shown that it has better packet losses than FMIPv6 acting alone; but a larger bandwidth is obtained with FMIPv6 acting alone. In case of H+F MIPv6, MAP encapsulates all the data packets addressed to MNs, and this overhead reduces the available bandwidth in the channel. But for overall performance, H+F MIPv6 has been found to be better.

(Lee et al., 2001) propose a scheme for fast and lossless handover method considering DAD in IPv6-based mobile/wireless networks. They have considered the fact that latency comes mainly from ND and DAD in stateless Auto-Configuration scheme. MN obtains NCoA before handover and PAR uses buffer management, making the proposed scheme fast and lossless. In the proposed scheme, MN receives several beacon signals containing the network prefix and decides whether it needs to change its AR by calculating the Received Signal Strength (RSS) from neighboring ARs. Handover initiates if another AR has higher signal strength than the current AR. PAR starts buffering the packets destined for MN. NAR, in the meantime, acts as a proxy so that it can respond to any potential DAD conflicts on its link for NCoA. NAR performs a valid check for NCoA by comparing ND cache entry with NCoA. PAR forwards the buffered packets to NAR after receiving signal for the same from NAR.

A scheme in which buffering of packets is done at PAR while MN transitions to a new network is proposed in (Park and Lim, 2002). Once MN completes registration and obtains a valid NCoA, PAR forwards the packets to MN at the new address.

Buffer management has been proposed with two traffic classes, namely high-priority class as real-time traffic with strict delay requirement such as voice; and low-priority class with tolerable delay and strict packet loss requirements such as pure data. They propose an extension to the IPv6 Router Advertisement which allows a router to advertise its ability to support Simple Buffering (SB), where SB is based on the general smooth handoff framework as specified in (Krishnamurthi et al., 2001). Different sub-options are also used; namely, Buffer Initialize (BI), Buffer Forward (BF) and Buffer Acknowledgement (BA). Incoming packets destined for OCoA are buffered in addition to being forwarded normally. When MN completes handover, it sends BF sub-option asking the buffered packets to be forwarded to NCoA.

A novel seamless handover architecture, S-MIP is proposed in (Hsieh et al., 2003). The proposal builds on top of hierarchical and fast-handover mechanism of MIPv6, in conjunction with a handover algorithm based on software-based movement tracking techniques. They argue that with such a combination, the performance is better, providing a lossless handover with low latency. Two distinct buffers are maintained at NAR in S-MIP architecture, one for packets forwarded from PAR (f-buffer) and one for the packets simulcast to the current network MN is in and potential access network MN will get attached to (s-buffer). NAR will start delivering buffered packets to MN after it receives Fast Neighbor Advertisement, signifying that MN has arrived at its network. NAR will attempt to transmit the packets in f-buffer and empty it before beginning to transmit from s-buffer. At PAR, it will only forward those packets which are not simulcast to NAR. In case that MN does not switch network immediately, it will therefore still be able to receive packets from PAR.

A scheme called Mobile IPv6 Cache is proposed in (Chung and Nelson, 2004). In the scheme, cache at HA stores packets during handover. When HA detects completion of handover, it will flush the appropriate part of its cache immediately. Hence, MN will receive a positive Binding Acknowledgement followed by a burst of packets to recover communications quickly. They argue that Mobile IPv6 Cache can be implemented in existing networks to improve communication performance across handovers.

3 PROBLEM FORMULATION

From different handover schemes discussed, it can be established that a combination of HMIPv6

and FMIPv6 has the advantage of reduction of signaling delay and message overhead (as in HMIPv6), and also support of fast handover by L2 triggers and minimal service disruption by tunneling (as in FMIPv6). But a straight forward integration of FMIPv6 with HMIPv6 would not be an efficient option. Such integration would induce unnecessary overhead for re-tunneling at the PARs and also inefficient usage of network bandwidth as FMIPv6 uses the tunneling between the previous and new ARs for fast handover. Hence, FHMIPv6, where tunneling is between NAR and MAP rather than between PAR and NAR, should perform better. MN exchanges signaling messages for handover such as RtSolPr, PrRtAdv, FBU, and FBACk with MAP. For buffering, larger buffer at AR can tolerate less frequent RAs and longer period of contact, but with added latency. On the other hand, more frequent RAs take up more wireless bandwidth and denser coverage requires more ARs (hence, more equipment). Balancing these factors is important for achieving optimal handover.

The latency involved with Anticipated Fast Handover protocol is mainly due to lack of knowledge about NCoA, time taken for DAD, signaling latency and L2 handover delay. The first requires some time for discovery of new AR and for BU. The second requires some time for the checking of uniqueness of NCoA acquired by MN. The third requires some time due to the signaling between MN, ARs and HA / CN(s). The delays are usually appreciable and can lead to packet loss. Effect of the first case can be reduced to some extent by using anticipation. Optimistic DAD (Moore, 2004), which is a modification of existing IPv6 ND and Stateless Address Auto-Configuration, could be one option to reduce the effect of the second. Alternatively, Address Pool based Stateful NCoA configuration for FMIPv6 (Proactive and reactive stateful schemes) could also be used (Jung et al., 2003). The scheme of Advance DAD (Han et al., 2003) is another option. Advance DAD scheme automatically allocates a globally routable IPv6 CoA for the use of MNs that participate in fast handover. Advance DAD is considered in this work.

Buffering eliminates packet loss; they can reside in ARs and store packets addressed to MN during handover period temporarily. When handover is complete and MN is attached to NAR, the stored packets are forwarded to MN. Buffering could be performed at NAR, in case of pre-registration, where MN acquires NCoA before it moves to the new point of attachment. Buffering could be performed at PAR in case of post-registration. Tunnel Buffering (TB) considers the situation where MN anticipates that it is about to move, but does not know where it is about to move to. In this case, MN can send a

special L-BU requesting that its traffic be buffered at MAP until it has determined its new link CoA (Moore et al., 2004). Once it has completed movement and gets attached to the new point of attachment, MAP forwards the buffered packets to MN and also starts tunneling the new packets destined for MN.

In this work, buffering is performed at NAR for FHMPv6 protocol (Jung et al., 2004). MAP will start forwarding packets destined to MN towards NAR after tunnel is established during HI/HACK. Hence, the packets are stored in the buffer at NAR till MN establishes link with NAR, after which, buffered packets are forwarded to MN.

3.1 Operational Detail

During normal operation, MN is connected to the current AR, called PAR. Packets destined to MN are routed from MAP via PAR in the wired link. In the wireless link, the packets are sent on the air to MN from PAR. A case of pre-registration handover is considered. MAP manages a 'Passive Proxy Cache' associated with its domain. The number of addresses kept in the cache depends on the value of the address pool.

The generation of globally routable addresses is performed in the background and DAD is performed on them. When DAD is complete, the addresses are stored in the cache and are reserved. But when MAP detects the use of any of the addresses present in the cache, through RD messages, it deletes the address from the cache. The address pool is continuously updated by generating new addresses, so that the addresses in the pool approach the pool size.

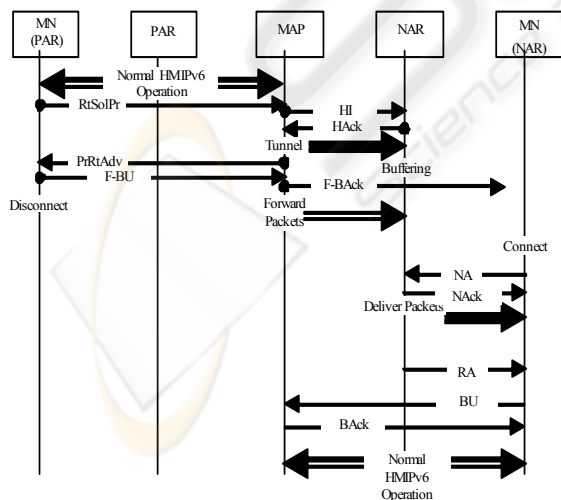

Figure 1: Signalling and Operations during and after Handover

To initiate fast handover, as a consequence of L2 handover anticipation trigger (Yegin et al., 2002), MN sends Router Solicitation for Proxy (RtSolPr) to MAP indicating that it desires to implement fast handover to a new point of attachment. RtSolPr contains an identifier for the new attachment point.

MAP will then send the Proxy Router Advertisement (PrRtAdv) containing the duplication free address from its cache and the address is removed from the cache. Meanwhile, MAP sends Handover Initiate (HI) message to NAR. In response to the HI message from the MAP, NAR sends handover acknowledgement (HACK) message and setup of the tunnel between MAP and NAR is complete. NAR starts buffering any packets tunneled to it by MAP. After receiving PrRtAdv from PAR, MN sends F-BU to MAP via PAR and disconnects from PAR. MAP in response to F-BU associates NCoA with OCoA and sends out acknowledgement F-BAck, which MN receives from NAR. NAR continues buffering the packets from MAP until it receives Fast Neighbor Advertisement (F-NA) message from the newly incoming MN after it has established link connectivity. In response to F-NA from MN, NAR sends out F-NAck to MN and starts delivering the packets which have been buffered. MN then follows the normal HMIPv6 operations by sending Local Binding Update (L-BU) to MAP. When MAP receives the new L-BU from MN, it will clear the tunnel established for fast handover after forwarding of the buffered packets is complete. In response to L-BU, MAP will send Local Binding Acknowledgement (L-BAck) to MN and the normal operation of HMIPv6 will follow. The signaling and operations are shown in figure 1 for the periods during and after handover.

In (Hsieh et al., 2002), forwarding of packets by PAR towards the NAR starts only after receiving BU (F-BU) and in (Jung et al., 2004), forwarding starts only after FBAck. But with these options, some packets tend to go towards PAR and reach PAR after MN has already left PAR. With such a provision, it was seen that packets are lost. This will be discussed a little later in the section on Simulation. If the packets are tunneled towards NAR right after HI/HACK, then this probability of loss is decreased. The increase in latency with this is also not very significant.

4 SIMULATION

Simulation was performed using Network Simulator-2 (ns-2) (The Vint Project). The version of NS-2 used was ns-2.1b7a, and the extension developed by Jorg Widmer (Widmer) was added. In

addition, the extension for FHMIPv6 (Hsieh) was also added on top of ns-2.1b7a and the NOAH extension. The resulting product was modified as required, the details of which are given in the following.

The modifications consisted of changing the point of sending different fast handover signals to MAP instead of PAR. In the extension for FHMIPv6 developed by Hsieh, the handover signal RtSolPr was sent to PAR by MN, HI and HAcK were communicated between PAR and NAR, and PAR sent PrRtAdv to MN. Our case required sending RtSolPr to MAP, HI and HAcK to be exchanged between MAP and NAR and PrRtAdv to be sent to MN by MAP. Separate provisions for FBu and FBacK were also added. MN sends FBu to MAP from PAR and receives FBacK from NAR.

Tunneling process starting after HI/HAcK was also implemented, by which MAP tunnels packets destined to MN towards NAR instead of PAR. In addition, buffering option was also added. Buffering was implemented in the ARs, where packets are buffered until MN attaches itself to NAR. Classifiers had to be modified for this. Classifiers sit inside a node and they use the computed routing table to perform packet forwarding. The buffer used is limited by size, number of packets it can store, and by the time limit for which the buffered packets are acceptable. The time limit is the time period after which, the packet loses its significance and hence is discarded.

4.1 Simulation Parameters

The simulation model that was used is shown in figure 2. The model used composed of HA, CN, MAP, ARs and other routers.

CN and HA were connected via the Internet to MAP. Router1 was included to simulate the connection of MAP to HA and CN via the Internet and a delay of 50ms from MAP and a bandwidth of 100Mbps was used. Since hierarchical structure was assumed, the routers for different subnets were connected to MAP.

All nodes below the MAP were members of the same domain, hence the constant delay of 2 ms was assumed for their links. The access routers, PAR and NAR, representing different subnets were connected via two different Intermediate Routers (Router2 and Router3) to MAP. The wired links were modeled as 10Mbps duplex link with 2 ms delay and 1000Kbps duplex link with 2 ms delay, from MAP to IRs and from IRs to ARs respectively. For the wireless medium, the LAN 802.11 access provided by ns-2 was used.

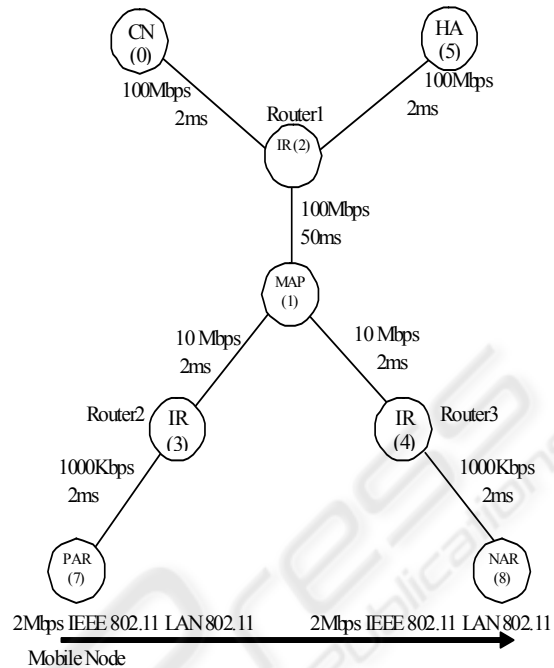

Figure 2: The Simulation Scenario

The traffic source considered was CBR, with UDP as the transport protocol with source at CN and Null Agent at MN. The data packet was taken to be of 512 bytes. The Cell sizes covered by the Access Routers were taken to be of 100 meters diameter with some area overlapping between them. Distance between the Access Routers was taken to be 70 meters. In each simulation run, MN starts moving towards NAR from PAR in a straight line at 10 seconds into the simulation. The values of speed and source data rate were varied for different scenarios. Three speeds were considered; 1m/s (approx. 4km/h), 15m/s (approx. 55km/h) and 25m/s (90km/h) as the pedestrian, normal vehicle and high vehicle speeds respectively. The performance during handover for change in the source data rate and MN speed was studied.

4.2 Simulation Scenarios

Various scenarios were considered for simulation; variations of packet loss, end-to-end packet delay and handover latency with CBR rate and speed of MN were studied. Each simulation run lasted for 60 seconds for MN speed of 1m/s and 40 seconds for other cases.

4.3 Results and Discussions

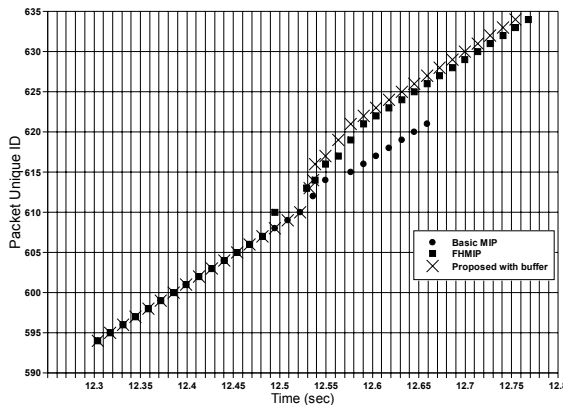

Figure 3: Packet Arrival for the Different Schemes

Figure 3 shows the packet arrival time for three different schemes, base MIPv6, F-HMIPv6 studied in (Hsieh et al., 2002), and the proposed scheme. From the figure, it can be said that the proposed scheme performs slightly better than that in (Hsieh et al., 2002). In addition, the packets that are lost for the scheme in (Hsieh et al., 2002) are not lost.

From simulation results, it is seen that a packet (packet ID 608) reaches MAP at 12.484secs. In case of the FHMIPv6 from (Hsieh et al., 2002), the packet gets forwarded to PAR, and hence gets lost because MN has already left the Previous Access Network. In the proposed scheme, however, the packet gets forwarded towards NAR and is buffered till MN attaches itself to NAR. Similarly another packet (packet 609) gets lost in the former case because it gets forwarded towards NAR but MN has not yet established link connectivity with NAR.

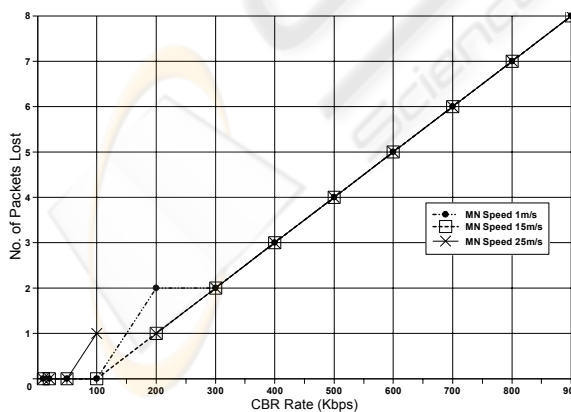

Figure 4: Number of Packets lost for Different Cases

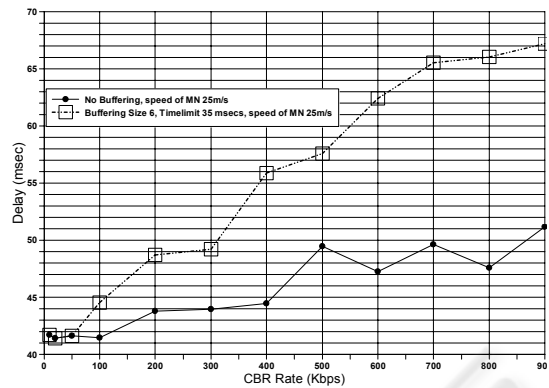

Figure 5: Handover Latency with and without Buffering

The difference in handover latencies with and without buffering widens with increasing data rate. The highest difference between the two latencies is for the highest data rate under consideration, for which more number of packets need to be stored. The difference is shown in figure 5.

But in the latter, it gets buffered and is sent towards MN when it establishes link connectivity with NAR. In case of Basic Mobile IPv6, a total of 14 packets get lost (packets 735-748) in the process of handover, without the fast handover provision.

From simulation, it was also observed that the number of packets lost in absence of buffering is proportional to the data rate and almost independent of MN speed, as the lost packet number is the same for all the speeds, except for a few cases for lower data rates, as seen from figure 4. After the initial transient, the packet loss shows constant linear relationship with the data rate for the three speeds under consideration.

Figure 6 shows the handover latency variation with data rate. Again, it also depends more on data rate than on MN speed. But compared to end-to-end delay, the dependence on speed is slightly more. The trend of handover latency with data rate is on the increment.

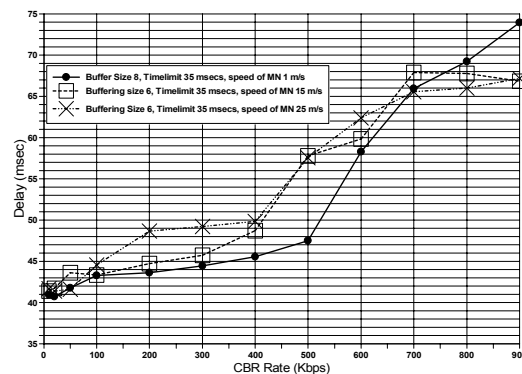

Figure 6: Handover Latency Variation with Data Rate

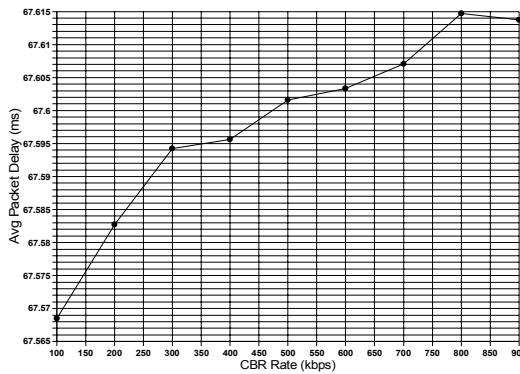

Figure 7: End-to-end Packet Delay with Buffering

End-to-end packet delay, from CN to MN, also has a direct relationship with data rate. However, it is also less dependent on MN speed when compared to data rate. The variation in the delay is almost linear with the data rate, as evident from figure 7.

When a specific data rate was considered and the variations of the different performance factors with MN speed were studied, the earlier conclusion that the factors were independent of MN speed was verified. The variations are shown in figures 8 and 9.

Handover latency variation with MN speed is not very significant, though some variations can be seen. The independence of packet loss variation with MN speed is more apparent than handover latency.

The end-to-end packet delay can also said to be not too much dependent on MN speed, again compared to the data rate. The variation does not change significantly with MN speed. From figure 9, it can be seen that initially the delay decreases with increasing speed, but is almost constant when saturation is reached for MN speed.

All of the performance parameters considered in this work have been rounded off to the nearest three digits in case of delays. Hence, these are of the order of microseconds.

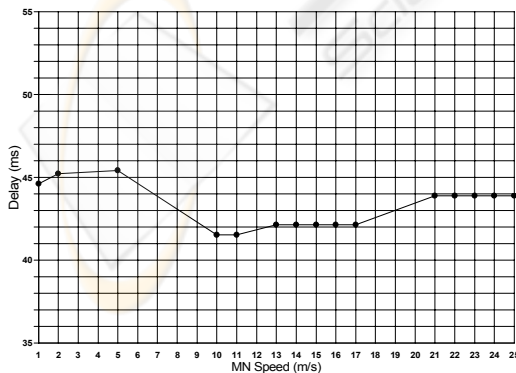

Figure 8: Handover Latency Variation with MN Speed

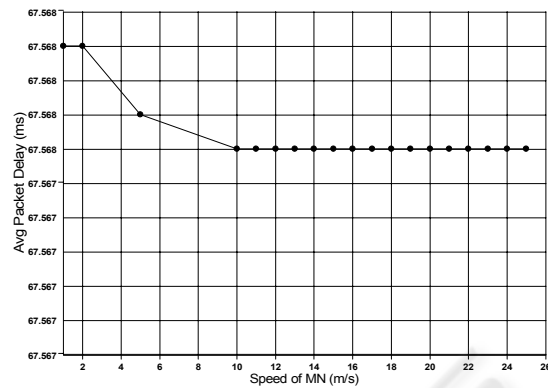

Figure 9: End-to-end Delay Variation with MN Speed

5 CONCLUSION

It can be concluded that if packets destined to MN are forwarded towards NAR after HI/HACK, slightly earlier than FBACK, the probability of loss of packets is decreased, without increasing the delay significantly.

The handover delay, end-to-end delay and loss of packets are quite independent of MN speed compared to data rate. In case of variable data rate, these are more dependent on data rate than MN speed. In case of a particular data rate also, there are some variations, but the variations are not very significant.

From the variations seen with MN speed and data rate, the conclusion could be drawn that the performance with VoIP applications, with voice considered CBR traffic, is better than for multimedia applications, with multimedia traffic being Variable Bit Rate traffic.

From the simulations, it was also observed that fast handover fails in some cases when the RtSolPr sent by MN is not received by PAR. Hence, the cell size, the transmission powers of Access Routers and MN also play a significant role in the overall performance. But these should be as small as possible for obvious reasons. As an extension to this work, performance with the variation in these parameters and also with the ping-pong effect considered could be studied.

REFERENCES

- Bound J., Camey, M., Perkins, C. and Droms, R., 2001. *Dynamic Host Configuration Protocol for IPv6 (DHCPv6)*, IETF Internet Draft, draft-ietf-dhc-dhcpv6-20.txt, October 2001.

- Castelluccia, C., 1998. *A Hierarchical Mobile IPv6 Proposal*, INRIA Technical Report No. 226, INRIA, November 1998.
- Chung, S.-L.J. and Nelson, R., (2004), "Improving Mobile IPv6 Performance Across Handovers", Thesis, WAND Research Group, March 2004.
<http://wand.cs.waikato.ac.nz/pubs/205/pdf/thesis.pdf>
- Han, Y., Choi, J., Jang, H. and Park, S., 2003. *Advance Duplicate Address Detection*, IETF Internet Draft, draft-han-mobileip-adad-01.txt, IETF, July 2003.
- Hsieh, R., Seneviratne, A., Soliman, H. and El-Malki, K., 2002. Performance Analysis on Hierarchical Mobile IPv6 with Fast-Handoff over End-to-End TCP, *Proceedings of GLOBECOM*, November 2002.
- Hsieh, R., Zhou, Z. G. and Seneviratne, A., 2003. S-MIP: A Seamless Handoff Architecture for Mobile IP, *Proceedings of INFOCOM 2003*, April 2003.
- Hsieh, R. (2003), *NS-2 Extension for FHMIPv6*, <http://mobqos.ee.unsw.edu.au/~robert/nsinstall.php>
- Jung, H.Y., Koh, S. J., Soliman, H. and Kim, D. Y., 2003. *Address Pool based Stateful NCoA Configuration for FMIPv6*, IETF Internet Draft, draft-jung-mipshop-stateful-fmipv6-00.txt, IETF, August 2003.
- Jung, H.Y., Koh, S. J., Soliman, H., El-Malki, K. and Hartwell, B., 2004. *Fast Handover for Hierarchical MIPv6 (F-HMIPv6)*, IETF Internet Draft, draft-jung-mobileip-fastho-hmipv6-04.txt, IETF, June 2004.
- Koodli, R., 2003. Ed., *Fast Handovers for Mobile IPv6*, IETF Internet Draft, draft-ietf-mobileip-fast-mipv6-08.txt, IETF, October 2003.
- Krishnamurthi, G., Chalmers, R.C. and Perkins, C.E., 2001. *Buffer Management for Smooth Handovers in IPv6*, IETF Internet Draft, draft-krishnamurthi-mobileip-buffer6-01.txt, IETF, March 2001.
- Lee, C.-W., Lee, J.H., Joo, S.-B., and Kang, C.-H., 2001, Fast and Lossless Handoff Method considering Duplicate Address Detection in IPv6-based Mobile/Wireless Network, *Proceedings SPIE Volume 4586, Wireless and Mobile Communications*, pp. 134-143, October 2001.
- Montavont, N., and Noel, T., 2003. Analysis and Evaluation of Mobile IPv6 Handovers over Wireless LAN, *Mobile Networks and Applications (MONET), Volume 8 Number 3*, pp. 643 – 653, December 2003.
- Moore, N. S., 2004. *Optimistic Duplicate Address Detection for IPv6*, IETF Internet Draft, draft-ietf-ipv6-optimistic-dad-02.txt, IETF, September 2004.
- Moore, N.S., Choi, J. and Pentland, B., 2004. *Tunnel Buffering for Mobile IPv6*, IETF Internet Draft, draft-moore-mobopts-tunnel-buffering-00.txt, IETF, July 2004.
- Pack, S., and Choi, Y., 2003. Performance Analysis of Fast Handover in Mobile IPv6 Networks, *Lecture Notes in Computer Science (LNCS), Volume 2775*, pp. 679-691, Springer-Verlag, September 2003.
- Park, B.S. and Lim, C.S., (2002), A New Mobile IPv6 based Buffering Scheme in the All-IP Network, *The 2002 International Technical Conference on Circuits/Systems, Computers and Communications*, July 2002.
- Perez-Costa, X., Torrent-Moreno, M., and Hartenstein, H., 2003. A performance comparison of Mobile IPv6, Hierarchical Mobile IPv6, Fast Handovers for Mobile IPv6 and their combination, *ACM Mobile Computing and Communications Review (MC2R), Volume 7, Issue 4*, October 2003.
- Thomas, S. and Narten, T., 1998. *IPv6 Stateless Address Autoconfiguration*, IETF RFC 2462, December 1998.
- Vint Project, The, *Network Simulator (ns), version 2*, <http://www.isi.edu/nsnam/ns>
- Widmer, *NOAH Extension for ns-2.1b7a*, <http://www.icsi.berkeley.edu/~widmer/mnav/ns-extension/>
- Yegin, A.E., Funato, D., El Malki, K., Gwon, Y., Kempf, J., Pettersson, M., Roberts, P., Soliman, H. and Takeshhita, A., 2002. *Supporting Optimized Handover for IP Mobility - Requirements for Underlying Systems*, draft-manyfolks-l2-mobilereq-02.txt, IETF Internet Draft, IETF, June 2002.